

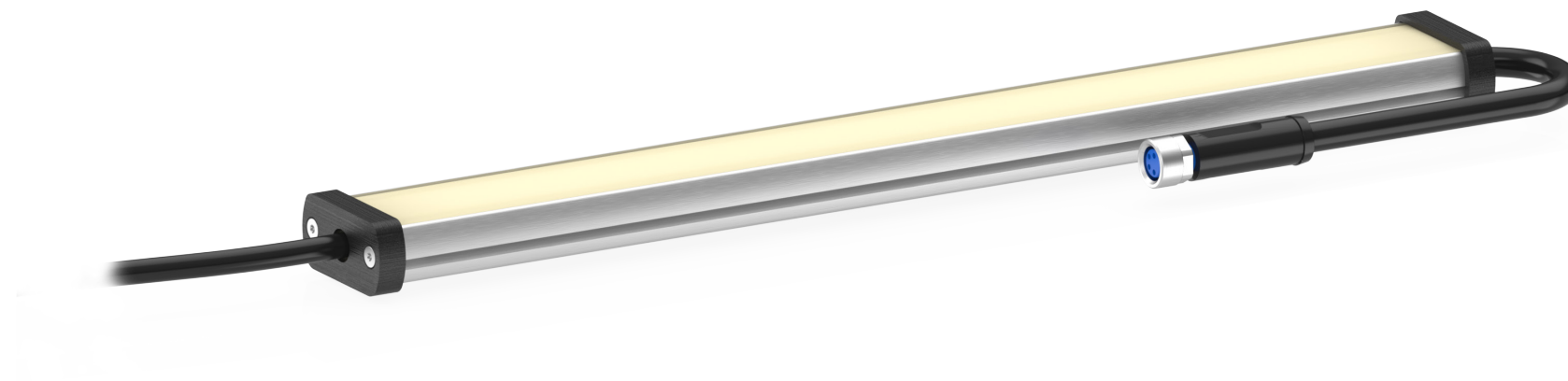







Funcional · SERIE SCX 3000K

lumher



24 V DC	125 lm/W	 ENSERIBLE	 75 mm INCREMENTAL	 FUNCIONAL	 CABLE
POWER 1x ECO 0,5x	IP40	 PWM DIMABLE	 CLASE III	36 MESES	 EU HECHO EN ESPAÑA

Especificaciones técnicas

Tensión de alimentación	24 Vdc ±5%	
Eficiencia luminica	125 lm/W	Blanco cálido
Regulación PWM (Máx 25 KHz)	min. 0%	máx. 100%
Tª de color	Blanco cálido	3000K
Ángulo de apertura	Semidifuso Ultradifuso	150° 150°
Nº máximo de módulos enseriables ⁽¹⁾	Power = 56	Eco = 112
Protecciones eléctricas	Sobretensiones transitorias Inversión de polaridad Estabilizador de corriente	SI SI SI
Índice de reproducción cromática (CRI)	Blanco cálido	≥ 90
Grado de protección	IP40	
Tipo de protección	Clase III	
Temperatura de operación	Versión Power Versión ECO	-10°C a +40°C -10°C a +50°C
Temperatura de almacenaje	0°C a +60°C	
Humedad max. relativa	80% (sin condensación)	
Material del cuerpo	Aluminio anodizado	
Material de las tapas laterales	Resina SLA	
Material del difusor	Policarbonato	
Tipo de conexión	Cable 2 m, cable con conector M8A	
Normativas	RoHs, CE	

(1) El nº que representa la longitud de la luminaria es el nº de módulos que posee.

Conexionado

Entrada M8A - Cable	Power	Eco	Dual
Pin 1 - Marrón	+24 Vdc	+24 Vdc	+24 Vdc
Pin 2 - Blanco	Sin conectar	Sin conectar	24 Vdc = Power 0 Vdc = Eco
Pin 3 - Azul	0 Vdc	0 Vdc	0 Vdc
Pin 4 - Negro	Sin conectar	Sin conectar	Sin conectar

Salida M8A	Power	Eco	Dual
Pin 1 - Marrón	+24 Vdc	+24 Vdc	+24 Vdc
Pin 2 - Blanco	Sin conectar	Sin conectar	Igual que Pin 2 de entrada
Pin 3 - Azul	0 Vdc	0 Vdc	0 Vdc
Pin 4 - Negro	Sin conectar	Sin conectar	Sin conectar

M8A Macho

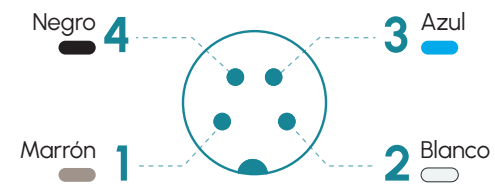

M8A Hembra

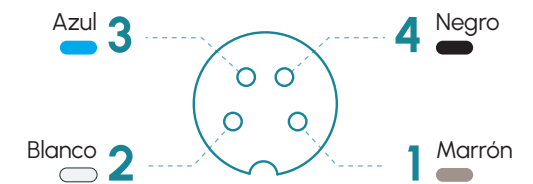

Anclajes

S00G2



SCX · 3000K

lumher

Dimensiones

Versión axial Cable - Cable M8A



Versión axial Cable M8A - Cable M8A



Tipos disponibles

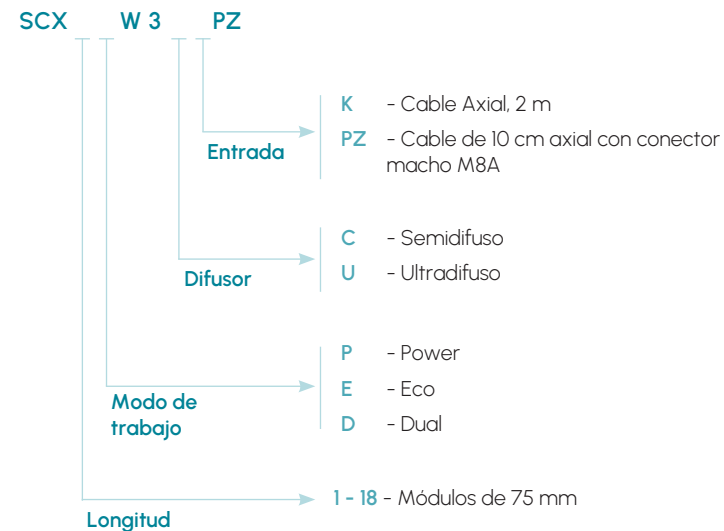

Medidas en mm

SCX · 3000K

lumher

Serie SCX · Blanco cálido 3000K

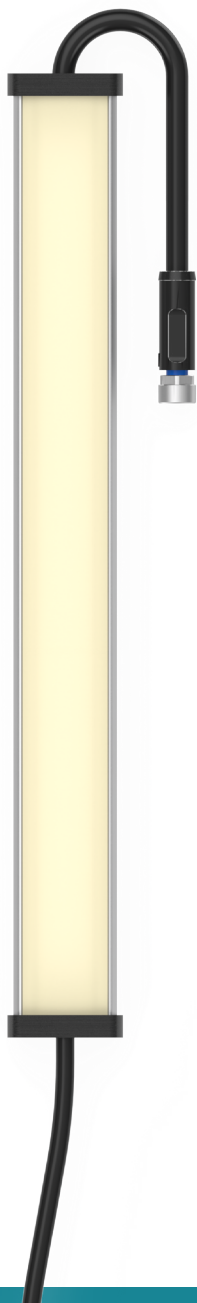

3000K
BLANCO CÁLIDO



RIESGO
FOTOBIOLOGICO
RG1 - BAJO

60.000h
VIDA ÚTIL

Tabla de características

	Longitud L1 ⁽²⁾ (mm)	Longitud L2 ⁽²⁾ (mm)	Peso (g)	Iluminancia Ev (lx) @ 1m				Flujo luminoso ⁽³⁾ (lm)		Potencia consumida (W)	
				SEMIDIFUSO		ULTRADIFUSO		POWER	ECO	POWER	ECO
				POWER	ECO	POWER	ECO				
SCX 01...	105	123	115	44	24	35	19	195	98	1,6	0,8
SCX02...	180	198	141	88	48	69	37	390	195	3,2	1,6
SCX 03...	255	273	167	132	71	104	56	586	293	4,8	2,4
SCX 04...	330	348	193	177	95	139	75	781	390	6,4	3,2
SCX 05...	405	423	219	221	119	174	93	976	488	8,0	4,0
SCX 06...	480	498	245	265	143	208	112	1.171	586	9,6	4,8
SCX 07...	555	573	271	309	166	243	131	1.366	683	11,2	5,6
SCX 08...	630	648	297	353	190	278	150	1.562	781	12,8	6,4
SCX 09...	705	723	323	397	214	312	168	1.757	878	14,4	7,2
SCX 10...	780	798	349	441	238	347	187	1.952	976	16,0	8,0
SCX 11...	855	873	375	485	262	382	206	2.147	1.074	17,6	8,8
SCX 12...	930	948	401	530	285	417	224	2.342	1.171	19,2	9,6
SCX 13...	1.005	1.023	427	574	309	451	243	2.538	1.269	20,8	10,4
SCX 14...	1.080	1.098	453	618	333	486	262	2.733	1.366	22,4	11,2
SCX 15...	1.155	1.173	479	662	357	521	280	2.928	1.464	24,0	12,0
SCX 16...	1.230	1.248	505	706	381	555	299	3.123	1.562	25,6	12,8
SCX 17...	1.305	1.323	531	750	404	590	318	3.318	1.659	27,2	13,6
SCX 18...	1.380	1.398	557	794	428	625	336	3.514	1.757	28,8	14,4

(2) Las versiones con entrada y/o salida radial tendrán como longitud L2, el resto serán L1.

(3) El flujo luminoso (lm) es antes de difusor.

lumher